

GP8.00126: The design of a low-cost Thomson Scattering system for use on the ORNL PhIX device

Presented at the
**54th Annual Meeting of the APS
Division of Plasma Physics**

**T.M. Biewer¹, J. Lore¹, R.H. Goulding¹,
D.L. Hillis¹, L. Owen¹, J. Rapp¹**

¹Oak Ridge National Laboratory

Providence, Rhode Island, USA
October 30th, 2012



Abstract

Study of the plasma-material interface (PMI) under high power and particle flux on linear plasma devices is an active area of research that is relevant to fusion-grade toroidal devices such as ITER and DEMO. ORNL is assembling a 15 cm diameter, ~4 m long linear machine, called the Physics Integration eXperiment (PhIX), which incorporates a helicon plasma source, electron heating, and a material target. The helicon source has demonstrated coupling of up to 100 kW of rf power, and produced $n_e > 4 \times 10^{19} \text{ m}^{-3}$ in D and He fueled plasmas, measured with interferometry and Langmuir probes (LP). Optical emission spectroscopy (OES) was used to confirm LP measurements that T_e is about 10 eV in helicon heated plasmas, which will presumably increase when electron heating is applied. Plasma parameters (n_e , T_e , n_0) of the PhIX device could be measured with a novel, low-cost Thomson Scattering (TS) system. The data would be used to characterize the PMI regime with multiple profile measurements in front of the target. Profiles near the source and target would be used to determine the parallel transport regime via comparison to 2D fluid plasma simulations.

This work was supported by the US. D.O.E. contract DE-AC05-00OR22725.

Motivation for Linear Devices*

ITER divertor channel

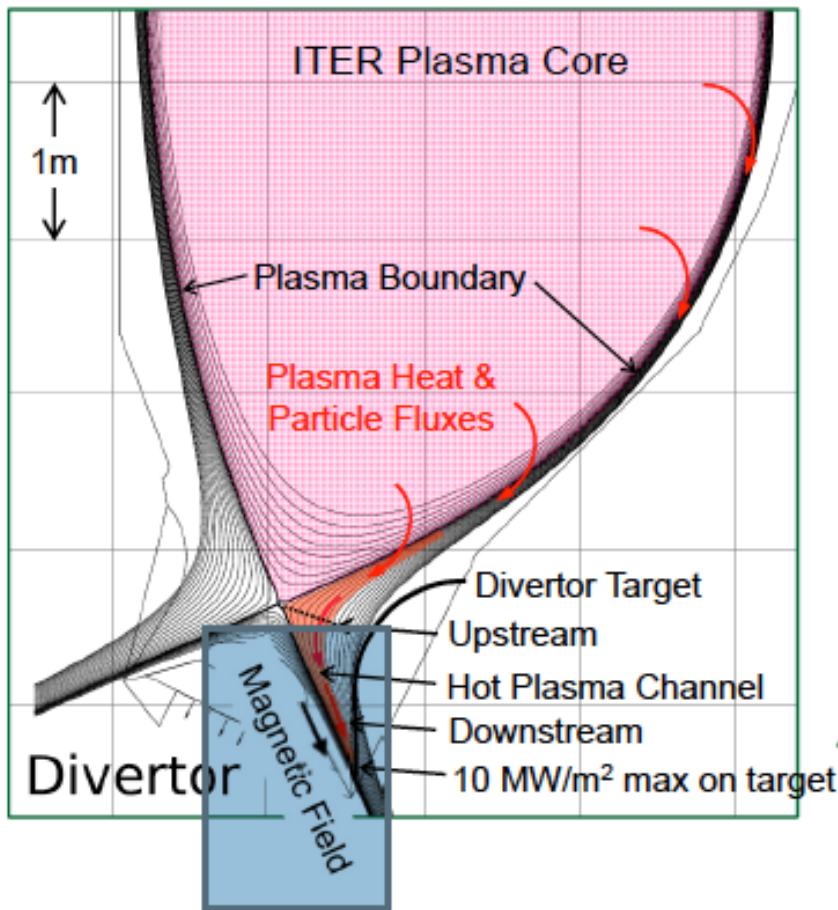

High-recycling, strongly coupled PMI regime

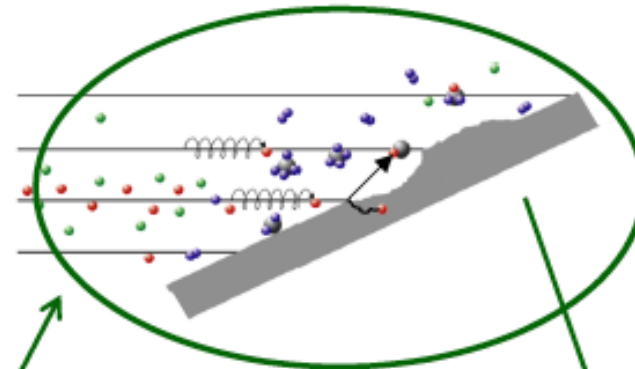

Linear plasma channel connected to a test target

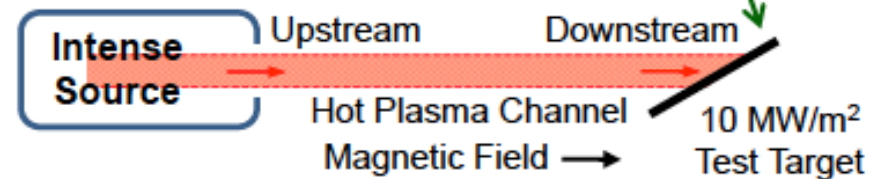

Motivation for Thomson Scattering

- Thomson Scattering (TS) is a well established diagnostic technique for high temperature plasma devices.
 - Measure electron distribution: n_e , T_e
 - Incorporate Rayleigh scattering for n_0 measurement
- Measurements exhibit high spatial and temporal localization that are non-perturbative to the plasma.
 - 10 ns laser pulse, $\sim <1 \text{ cm}^3$ beam/sightline intersection volume
- Probe-based measurements have yielded preliminary data on helicon and ECH experiments at ORNL, but nominally incompatible with higher power flux (and rf noise) of PhIX.
 - “Clean” (probe/anode free) is a feature of PhIX for PMI studies

Physics Integration eXperiment (PhIX)

(helicon + electron heaters)

- Investigation of production (rf-helicon) and heating of an overdense plasma by whistler and electron Bernstein waves (EBW), including:

- ionization cost, gas utilization efficiency
- electron heating efficiency
- interactions between plasma production and heating regions
- effects of target boundary on source (e.g., recycling, impurities, potential modification)

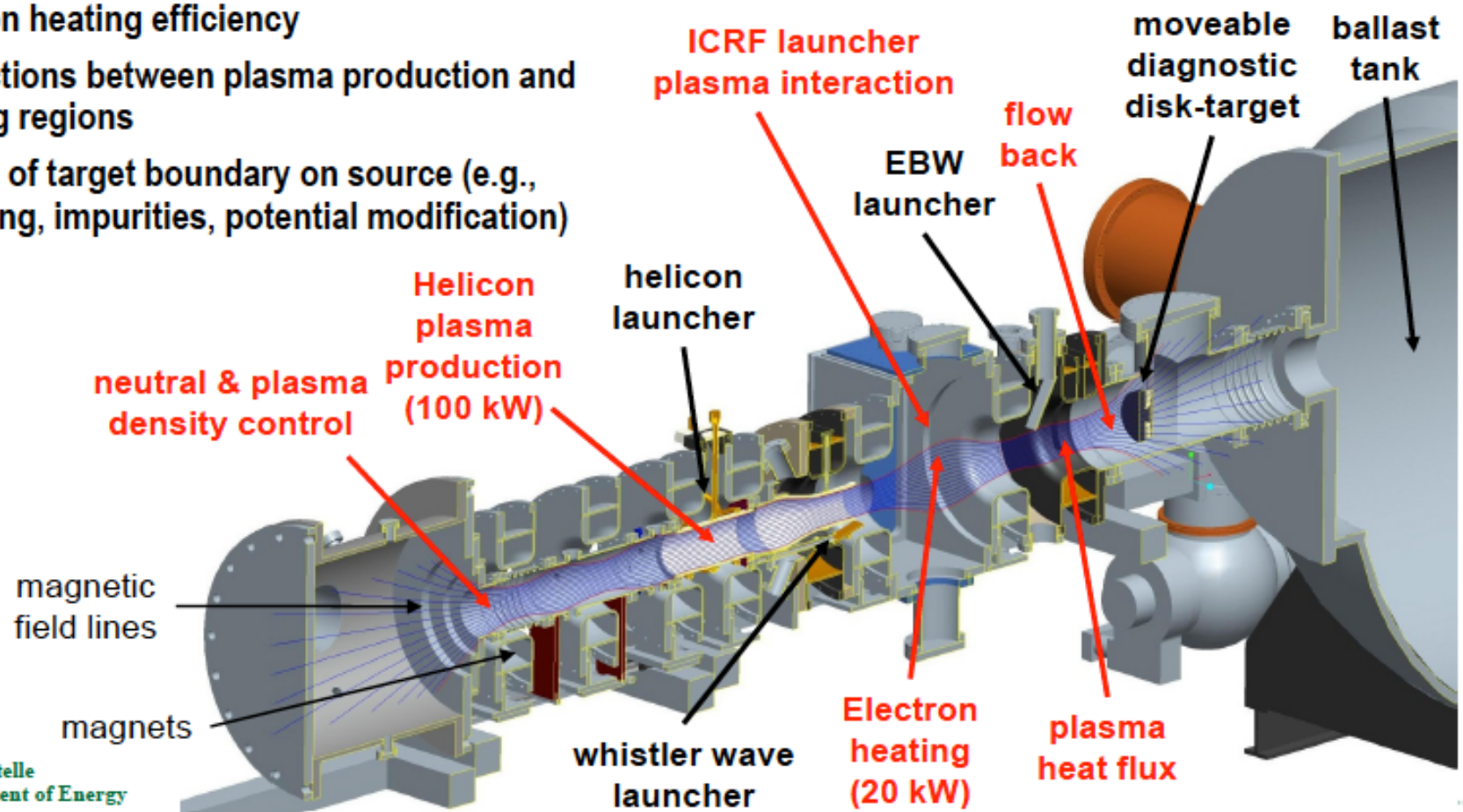
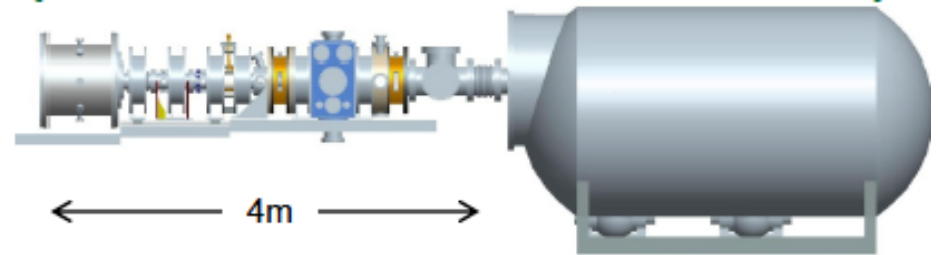

PhIX Assembly Underway

For more information see: (Thursday AM, this meeting)

TP8.00077 “The PhIX High Intensity Source”, R.H. Goulding, *et al.*

TP8.00076 “Design of an ICRH antenna for RF-plasma interaction studies”,
J.B.O. Caughman, *et al.*

TP8.00075 “SOLPS modeling of the ORNL helicon and PhIX”, L.W. Owen, *et al.*

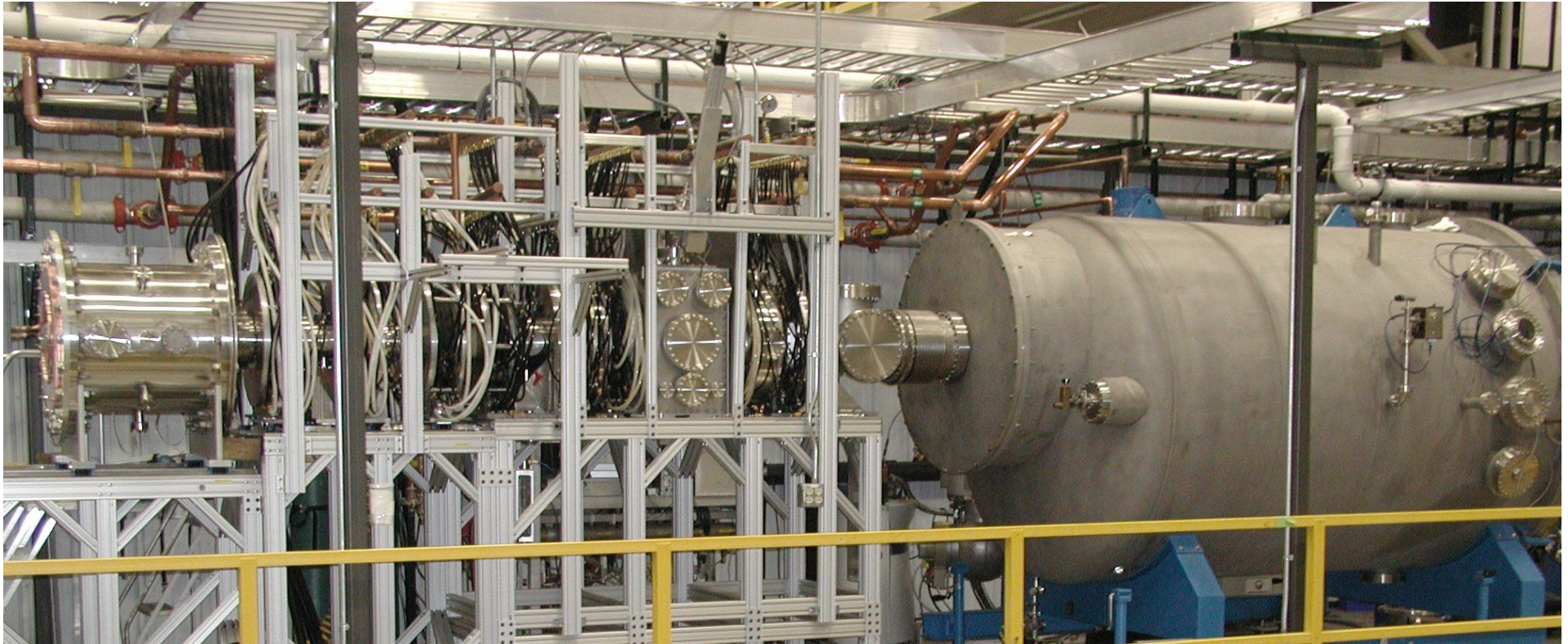

PhIX Diagnostic Access Ports

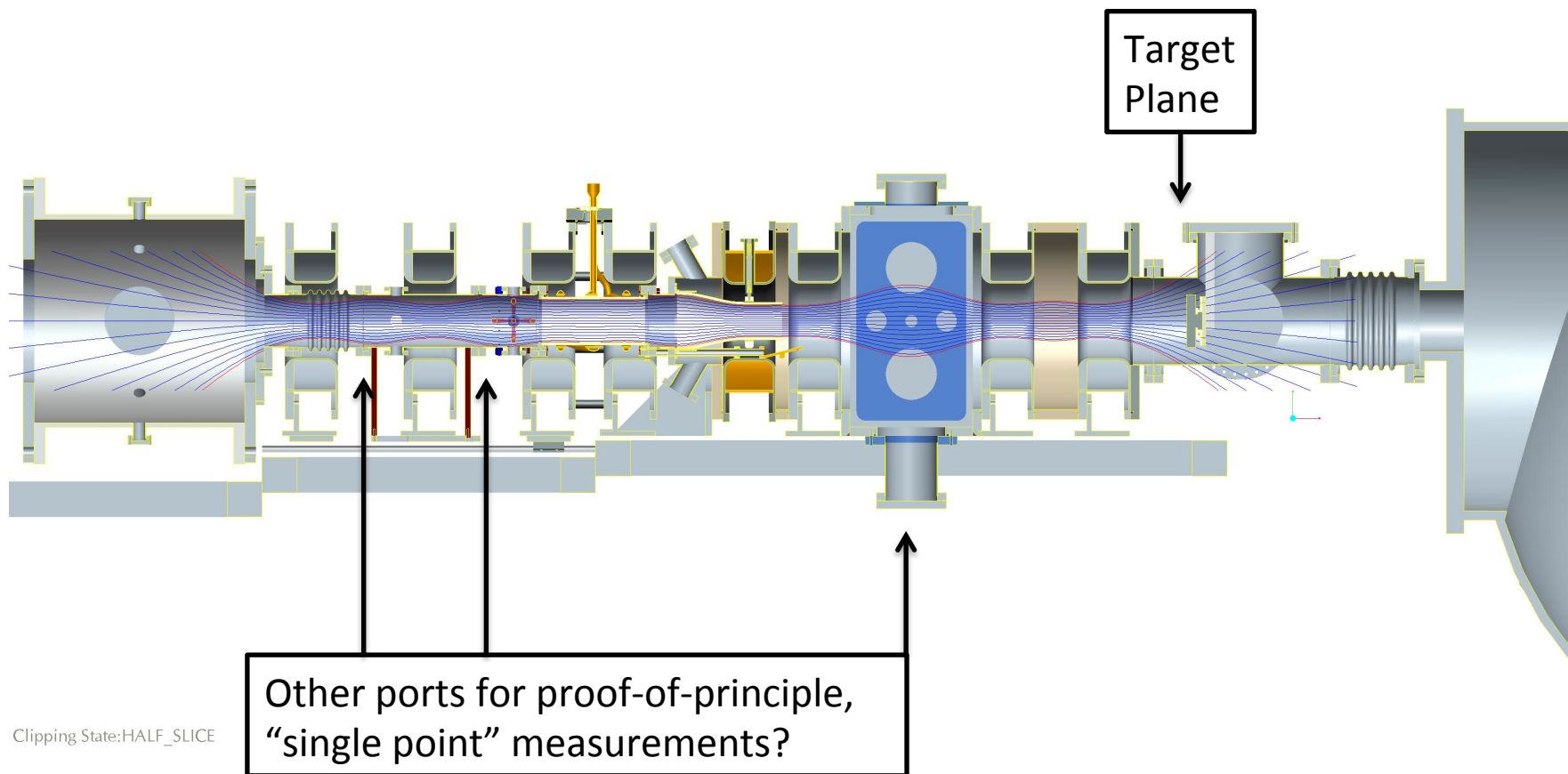

PhIX Experimental Hall: Bldg. 7625

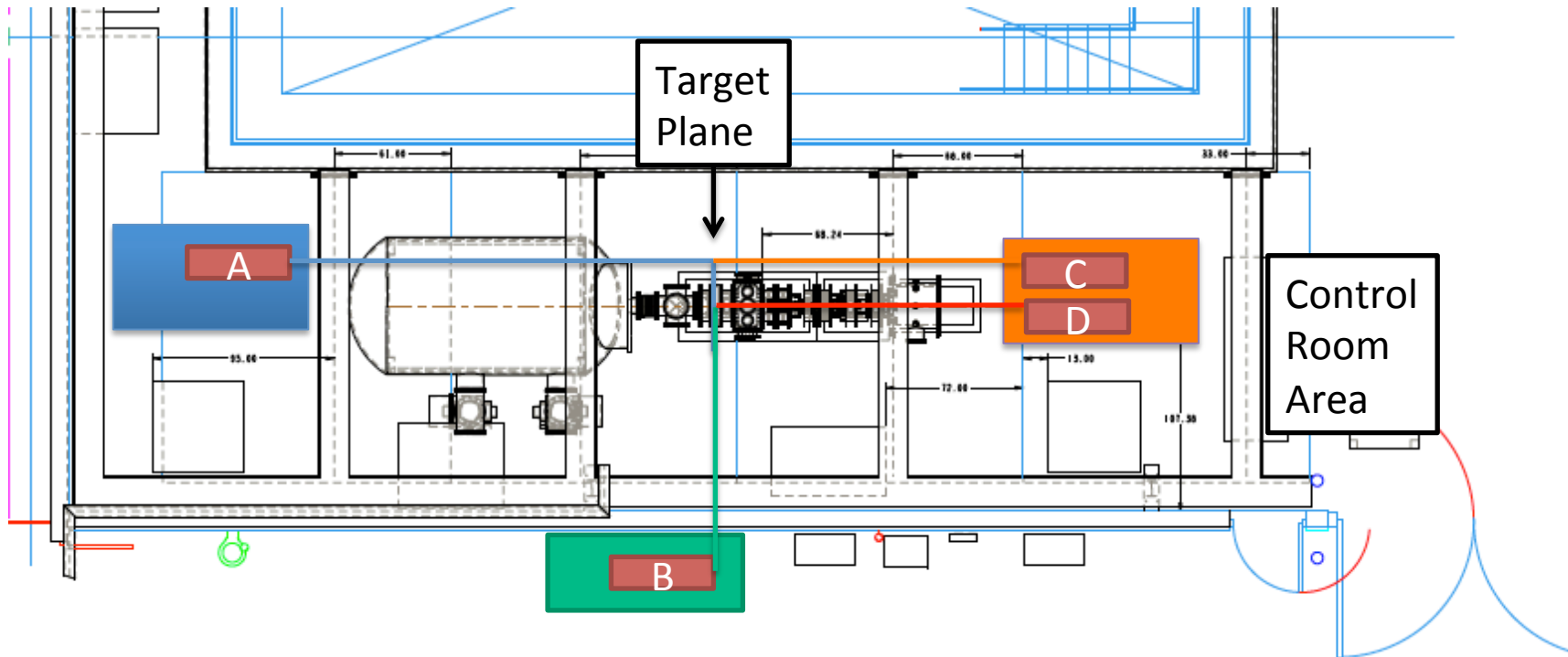

- 3 candidate areas (blue, green, orange) to locate lasers for TS (A,B,C).
 - Green area is outside machine area: wall penetration needed, but access available during PhIX operation
- Laser needs to ultimately cross the axis of the device at the “Target Plane.”
- Temporary installation may allow for on-axis beam (D), or “proof-of-principle” measurement at other port “crosses” (see slide #7).
- Beam lines need to be enclosed.

PhIX Target Region

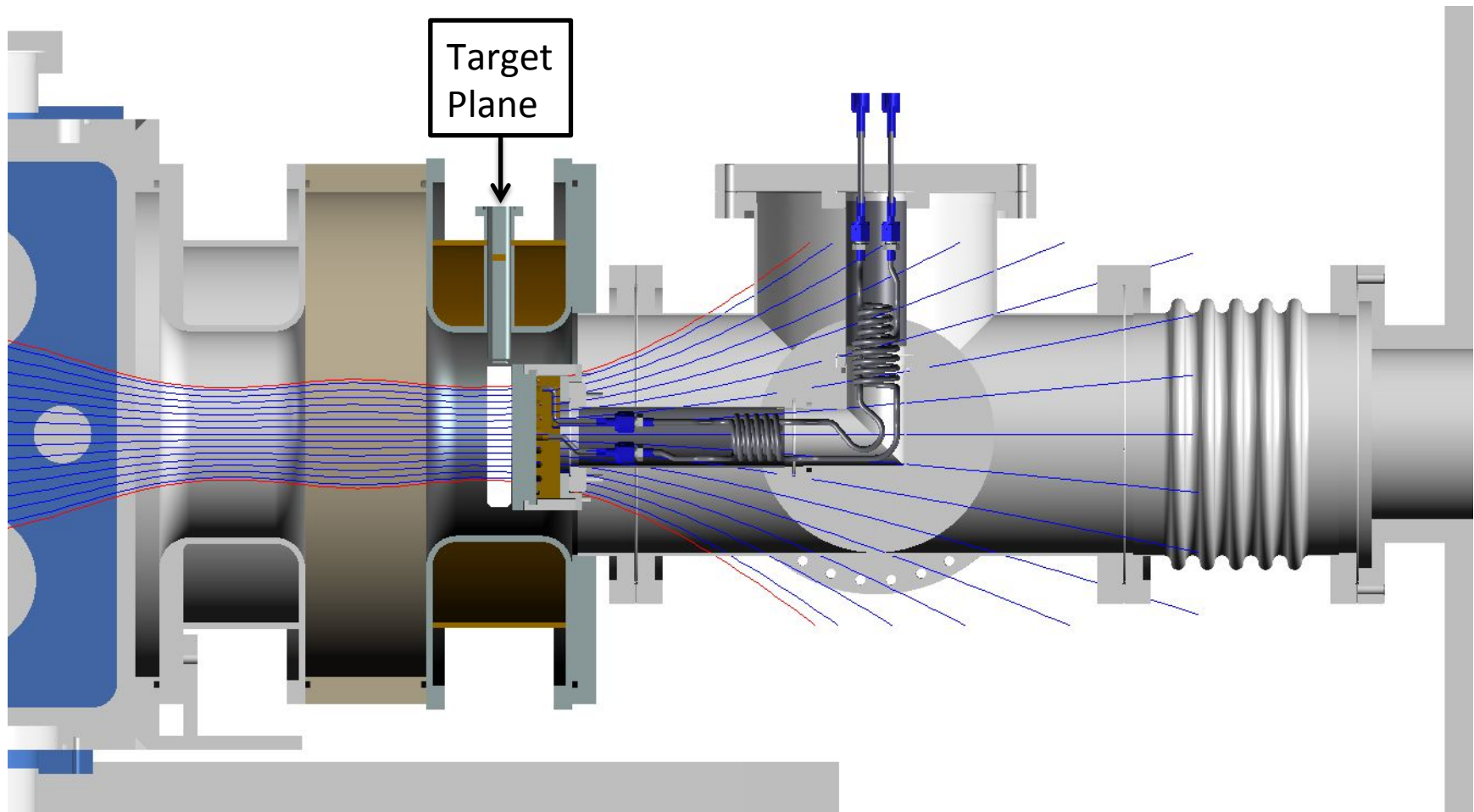

9 **Box ports in “split coil” allow for good diagnostic access at Target Plane.**

Managed by UT-Battelle
for the U.S. Department of Energy



“Split Coil” Geometry at Target

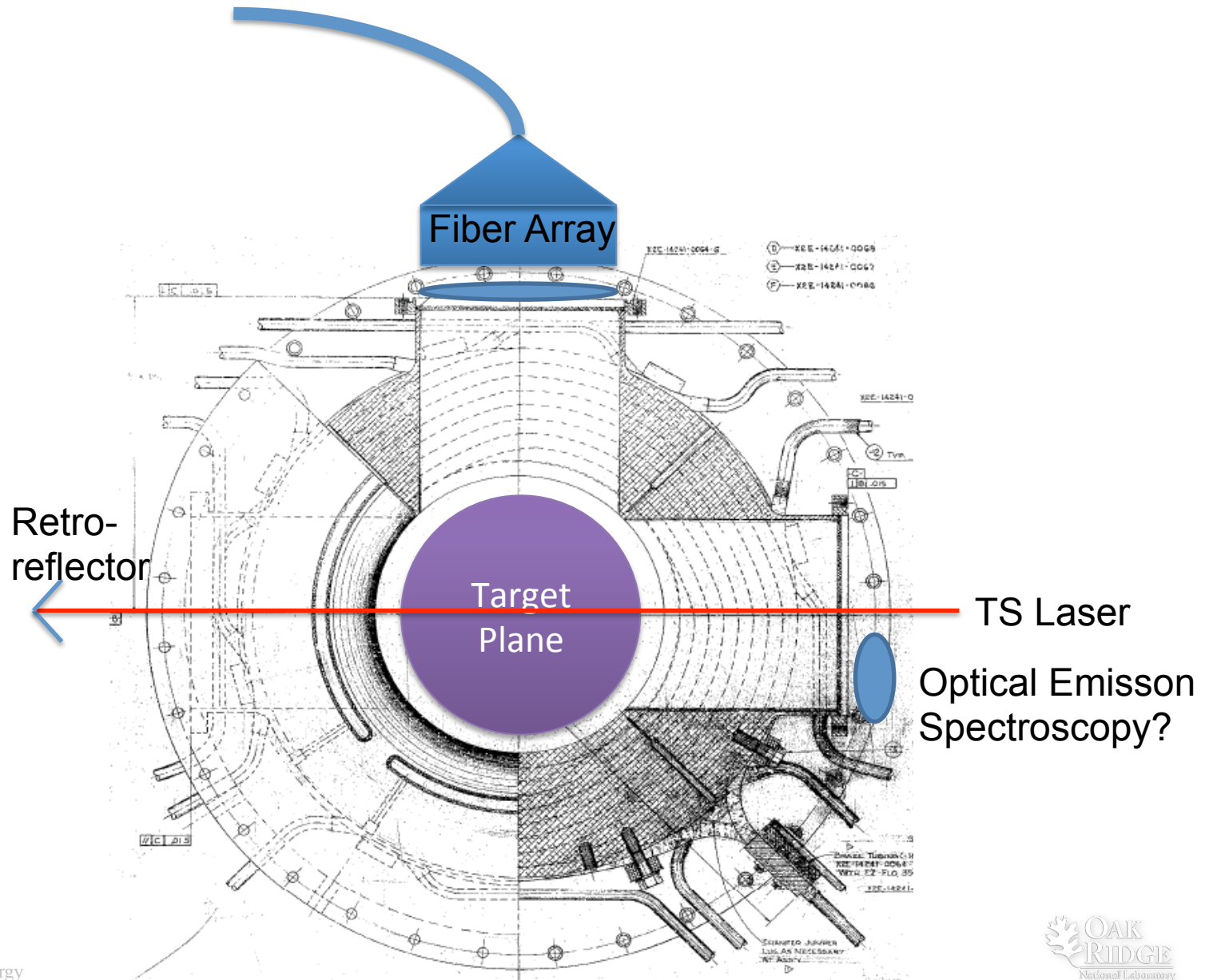
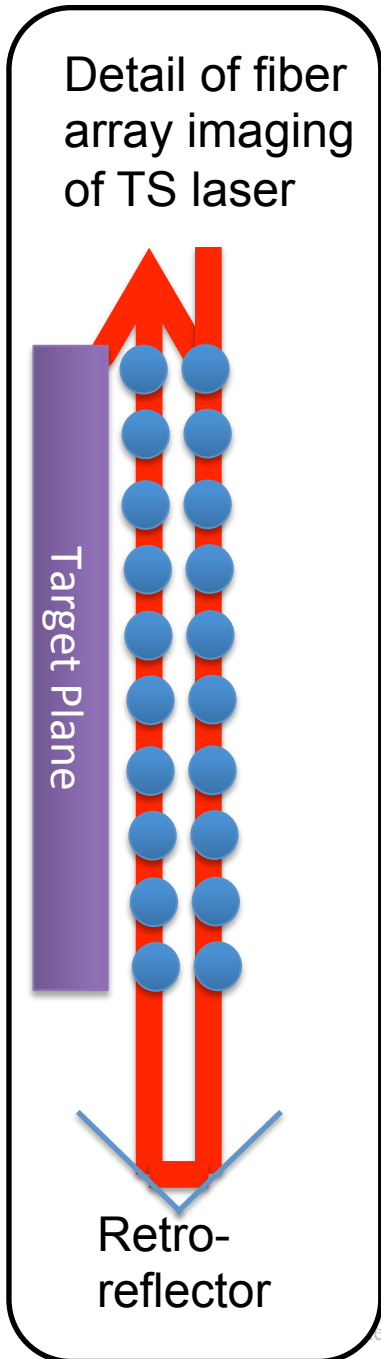

Innovative & Low Cost Design

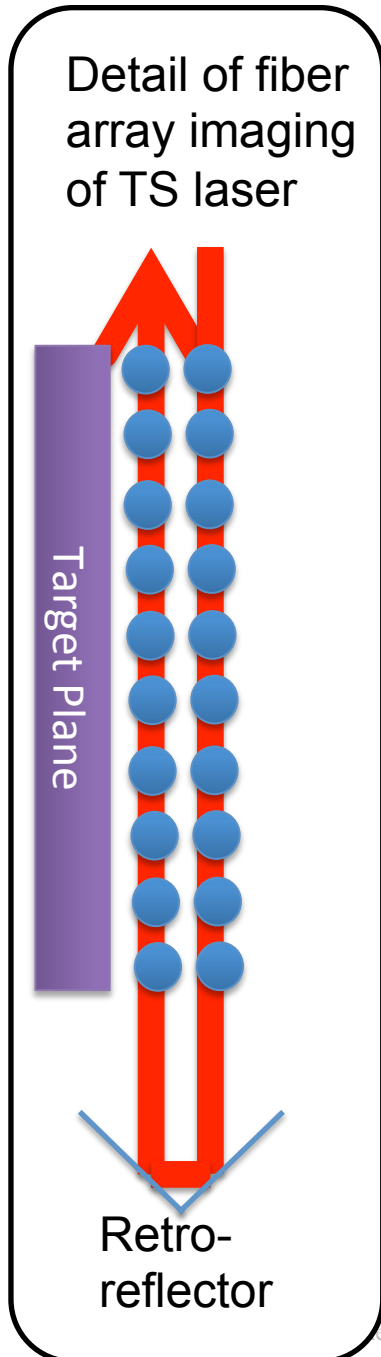

- **Double passing an off-set Nd:YAG laser allows for “true,” simultaneous (~ 1 ns) 2D TS measurements of n_e , T_e , n_0**
 - “2D TS” at C-Mod utilized beam steering between laser pulses (20 ms bet. pulses)
 - “2D TS” at ASDEX utilized 6 radial staggered lasers, fired sequentially (2 μ s bet. pulses)
- **Accomplished on a single spectrometer & detector eases alignment/calibration and reduces cost**
 - “2D TS” at C-Mod utilized 6 spectrometers
 - “2D TS” at ASDEX utilized 16 spectrometers and 6 lasers

Plasma/Neutral Modeling of PMTS

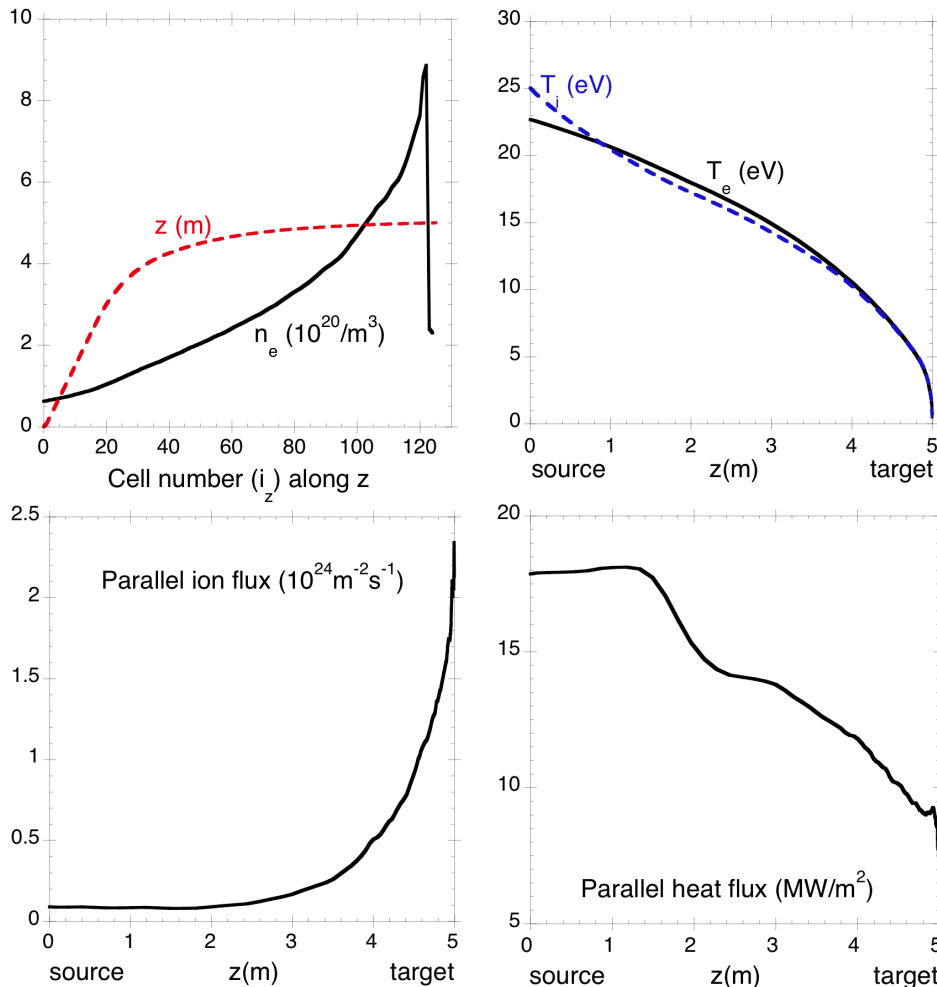

Figure: (a) electron density and Z-coordinate as function of cell number of B2-Eirene grid; (b) T_e and T_i as function of z-axis; (c) parallel ion flux as function of z-axis; (d) parallel heat flux as function of z-axis

12 Managed by UT-Battelle
for the U.S. Department of Energy

- Realistic 2-D modeling using SOLPS 5.0 (B2.5/EIRENE)
- Solves conservation equations for
 - density of each charge state
 - parallel momentum of each charge state
 - electron energy, ion energy, charge
- Includes models for plasma transport
 - Parallel: classical along field lines
 - with particle and heat fluxes limited to simulate kinetic effects
 - Radial: D , χ_e , χ_i
 - ExB and grad B drift effects available but not yet included.
 - Neutral transport: Kinetic, using the Eirene Monte Carlo



Spectrometer

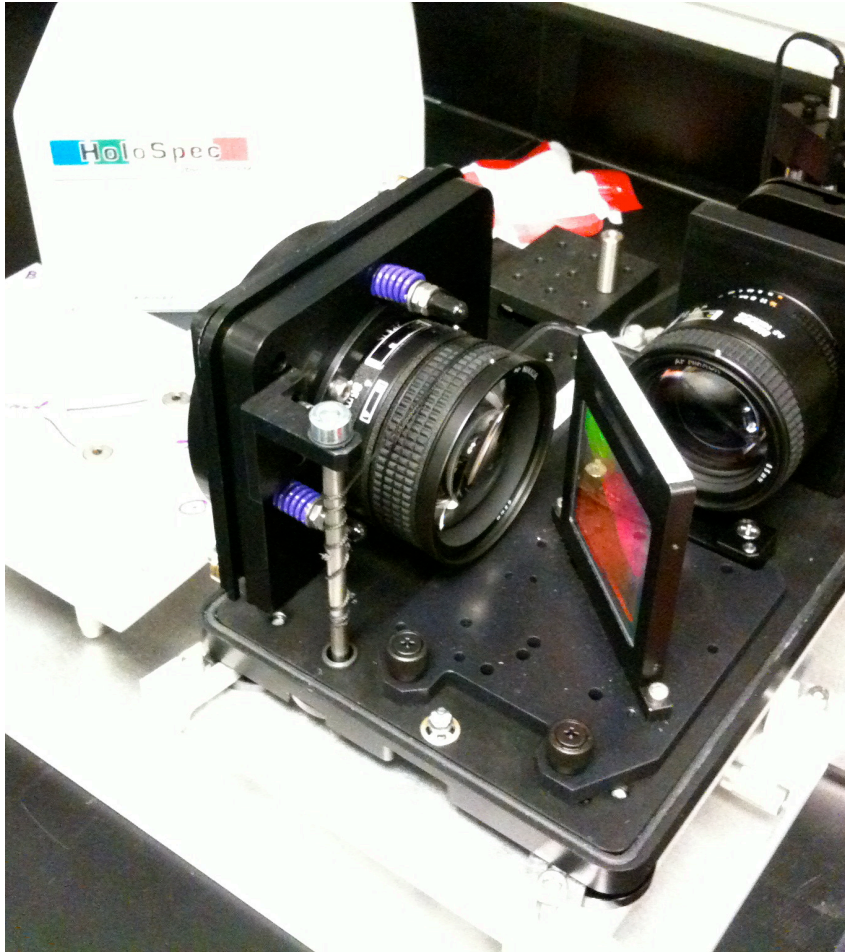

- Kaiser Optical: HoloSpec f/1.8 (~\$7k)
- Short focal length
- Transmission grating, high throughput, fixed wavelength
 - “low” dispersion: ~\$3k
 - “high” dispersion: ~\$7k
- 85 mm input lens
- 85 or 58 mm output lens (have), also 50 mm lens at JET
- Mounting hardware (have)

CCD Camera

- iCCD: P.I. PI-MAX3 1024i
- Configurations
 - 45% QE at 532 nm: Gen III, \$61k (bought)
 - 15% QE at 532 nm: Gen II, \$50k
- 2 ns minimum exposure
- 13 micron pixel, 13 mm chip
 - 85 mm lens
 - 10x 1 mm fiber
 - 17x 600 micron fiber
 - 58 mm lens
 - 15x 1 mm fiber
 - 25x 600 micron fiber

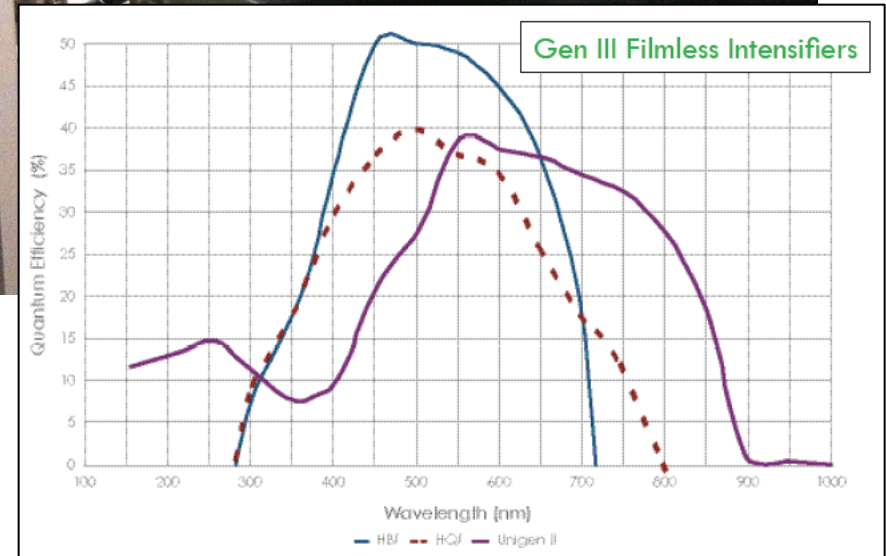
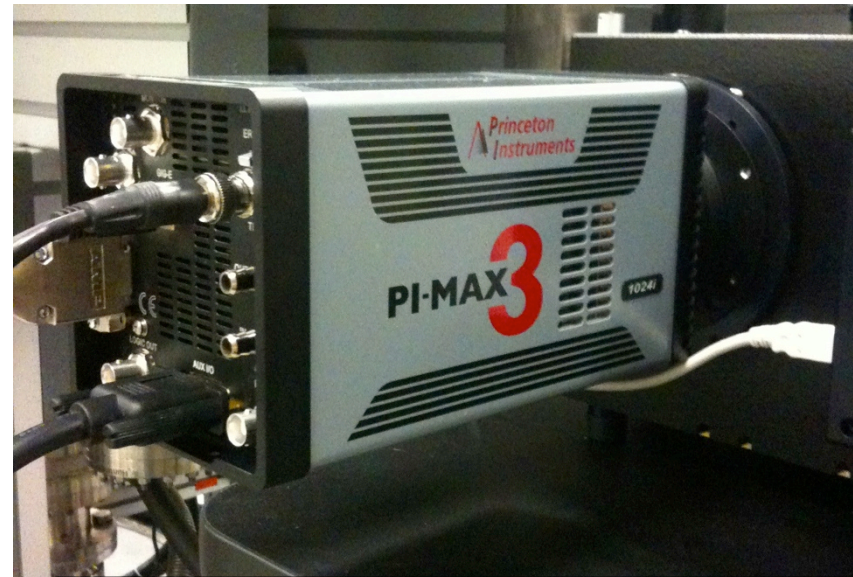

Available Fiber Bundle Configurations

2x10, “low disp”, 1 mm fibers

- Currently at JET (in storage for 2+ years)
- Entrance slits: 150, 250, 400 microns
- 2m long, SMA termination
- 532 nm “HSG” grating ~\$3k
- Need (else 10 channels only) narrow BP filter to separate 2 columns (~\$3k)
- 2x more light/channel (1mm v. 0.6 mm on same slit)

1x17, “high disp”, 0.6 mm fibers

- Currently at LTX (in use, but to be replaced in FY13)
- Entrance slits: 75, 150, 250 microns
- 7m long, SMA termination
- 532 nm “HDG” grating ~\$7k

Laser Options

- Many affordable options and configurations exist due to industrial use of Nd:YAG lasers.
- Frequency doubling to 532 nm halves the laser energy output, but shifts the scattered light spectrum into the visible.
 - Higher QE of camera detectors
 - ~100's of pixels v. ~10 fpc channels cover spectrum

Litron Lasers

	Laser			
	850mJ	1000mJ	1250mJ	2000mJ
Laser, PS, cooler, software	32	39	45.5	75
Training & Install (8.5-10)	9	9	9	9
Shipping, Duties	1.6	1.95	2.275	3.75
Laser total	\$42.6k	\$49.95k	\$56.7k	\$87.75k
Note	850mJ is air-water cooled			
Note 22	Energy is 50% at 532nm			

SELECT THE EXACT LASER TO MEET YOUR REQUIREMENTS

		Required Energy Output (mJ) at Wavelength (nm)					
Wavelength (nm)	266nm				<100mJ	100-200mJ	200+mJ
	355nm			<100mJ	100-200mJ	200-400mJ	400+mJ
	532nm		<100mJ	100-200mJ	200-400mJ	400-1000mJ	1000-2000mJ
	1064nm	<100mJ	100-200mJ	200-400mJ	400-1000mJ	1000-2000mJ	2000-3500mJ
Frequency (Hz)	10Hz			○	○	○	○
	20Hz			○	○	○	○
	30-50Hz		○	○	○	○	○
	50-100Hz		○	○	○	○	
	100-200Hz	○	○	○	○	○	
	200Hz	○	○	○			

Please click on the  that matches your requirements to go directly to that product.

TS Spectra Simulations

2x10, “low disp”, 1 mm fibers

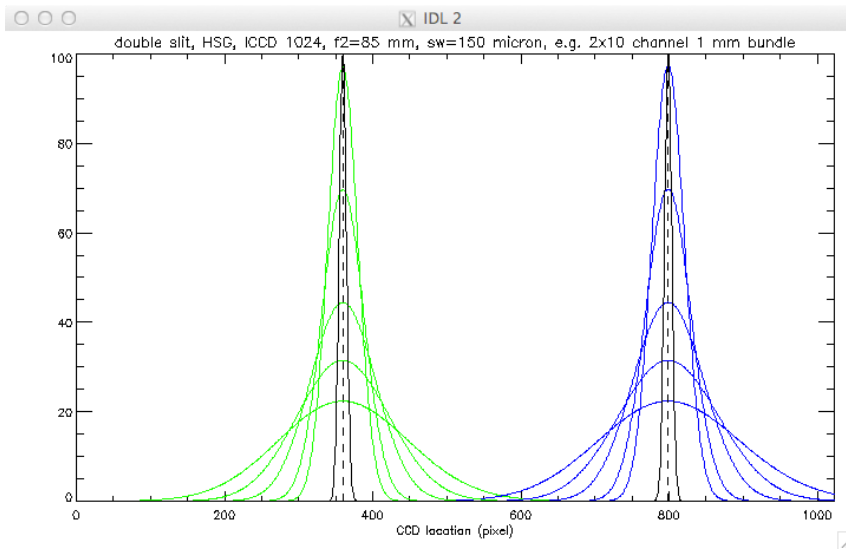

1x17, “high disp”, 0.6 mm fibers

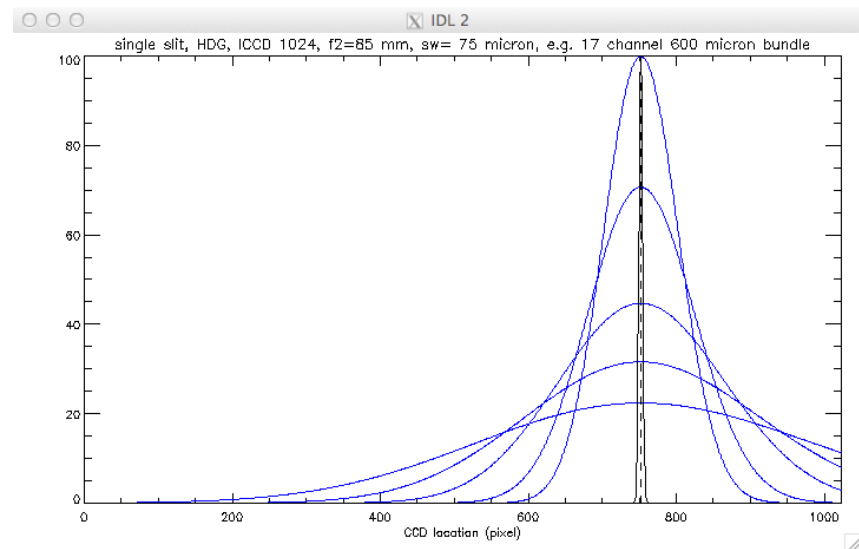

- Figures show the simulated spectra on the image plane (iCCD chip), utilizing the detection hardware described on the previous slides.
- Nd:YAG laser line (black) convolved with realistic instrument function
- TS spectra (green & blue) for 1, 2, 5, 10, & 20 eV plasmas at constant (arb.) e^- density

TS Spectral Coverage

- Xe I “pen lamp” lines convenient for calibration
- W I (522 nm) within spectral range (simultaneous OES measurement)
- Realistic instrument function represents width of neutral (Rayleigh scattering) peak in TS spectrum.

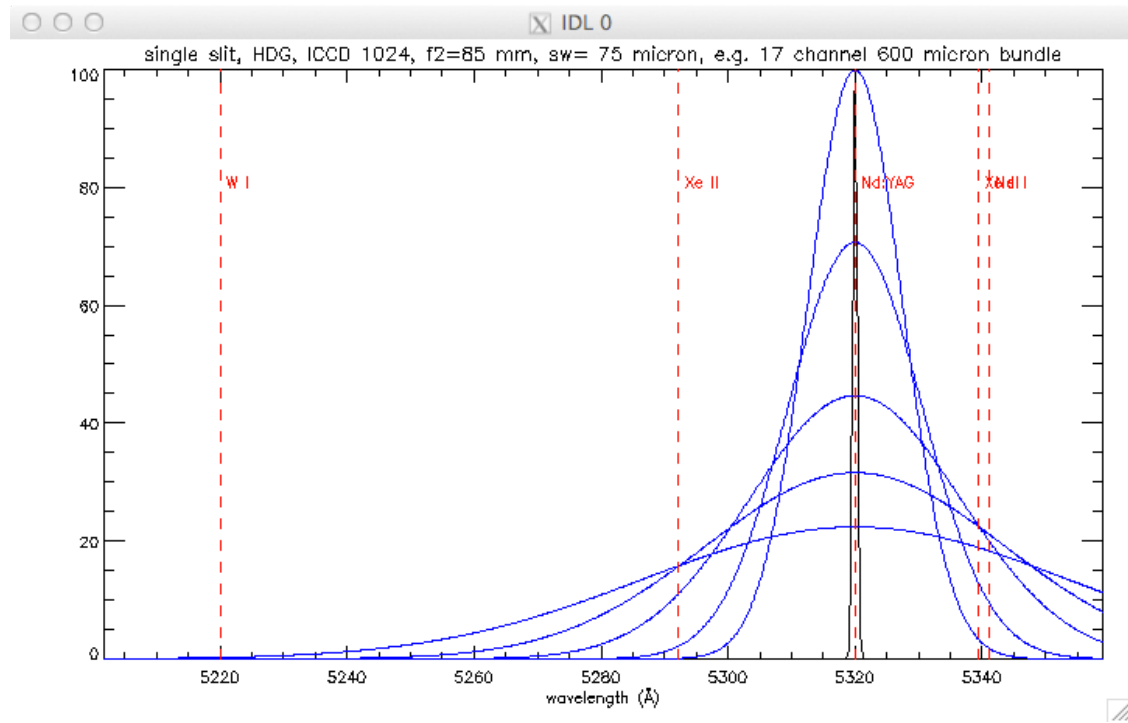

T_e spectra (blue) for 1, 2, 5, 10, 20 eV at constant n_e

Bremstrahlung and S/N Ratio

- We will double the Nd:YAG laser frequency ($\lambda = 532\text{nm}$)
 - This roughly halves the laser energy
 - **850mJ laser @ 1064nm**, $n = 1e19$, $T = 10\text{eV}$, $Z = 1$, beam width = 1cm, $QE = 0.9$, solid angle = $2.5e-2$, Brem volume = $1\text{cm} \times 15\text{cm}$, **dt_brem = 2ms**
 - **S/N ~ 40**
 - **425mJ @ 532**, dt_brem = 2ms
 - S/N ~ 10
- But, since we got an iCCD (say dt_brem = 100ns), $QE = 0.5$ (425mJ @ 532)
 - S/N ~ 100, ($QE = 0.1 \rightarrow S/N \sim 50$)
- Other options
 - 2ms camera at $QE \sim 0.1$, 850mJ @ 1064nm $\rightarrow S/N \sim 13$
 - 425mJ @ 532nm, 20ns gate iCCD, $QE = 0.5 \rightarrow S/N = 100$
 - 625mJ @ 532nm, 20ns gate iCCD, $QE = 0.5 \rightarrow S/N = 125$

$$\frac{S}{N} \sim \sqrt{\frac{Q\Omega_s L}{DdZ\Delta t_{collect}}}$$

Using Available LD 529 Grating & Filter

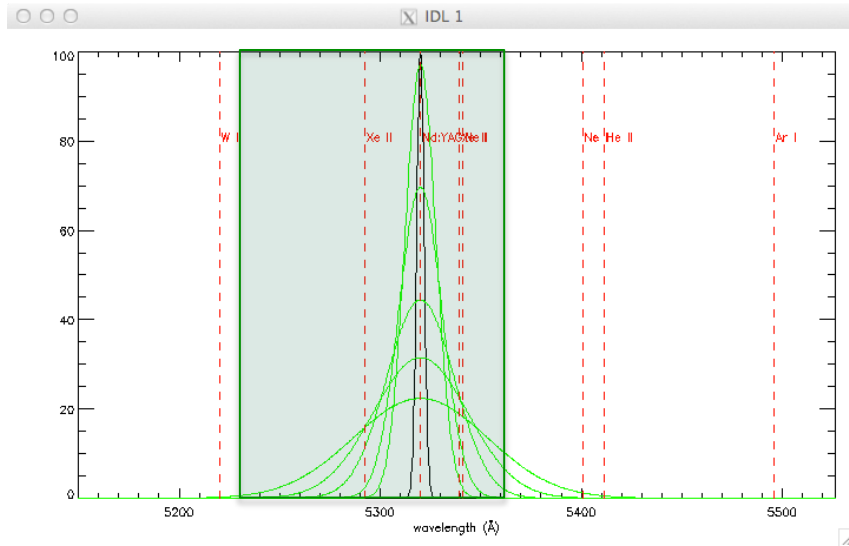
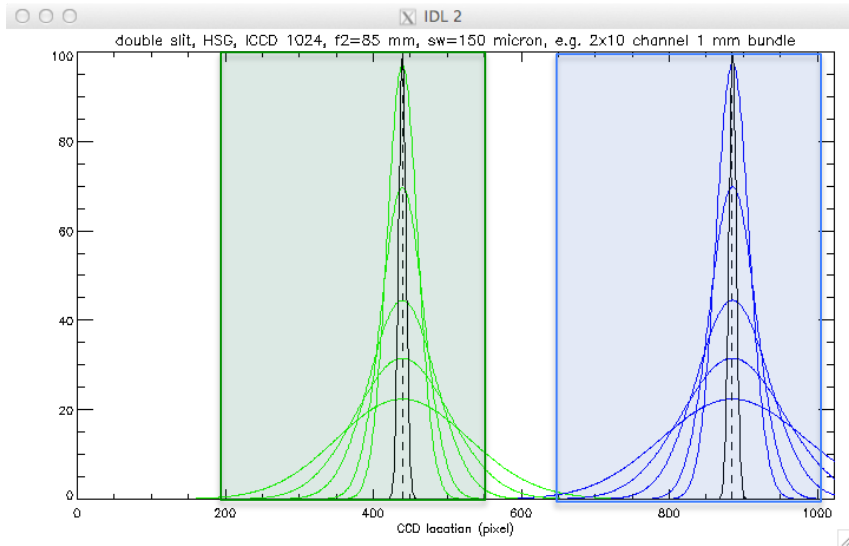

- Initial budget did not allow for purchase of a 532 nm grating for TS.
- A “low disp” 529 nm grating (for CXRS measurements of C VI) and BP filter could be returned from JET.
 - Sufficient spectral overlap to be useful for TS on PhIX
- 2x10 1mm fiberbundle also in storage at JET.
 - 20 channel system for TS measurement
 - 10 channel system to include W I (522 nm) and He II (541 nm) simultaneous OES measurements

First Steps . . .

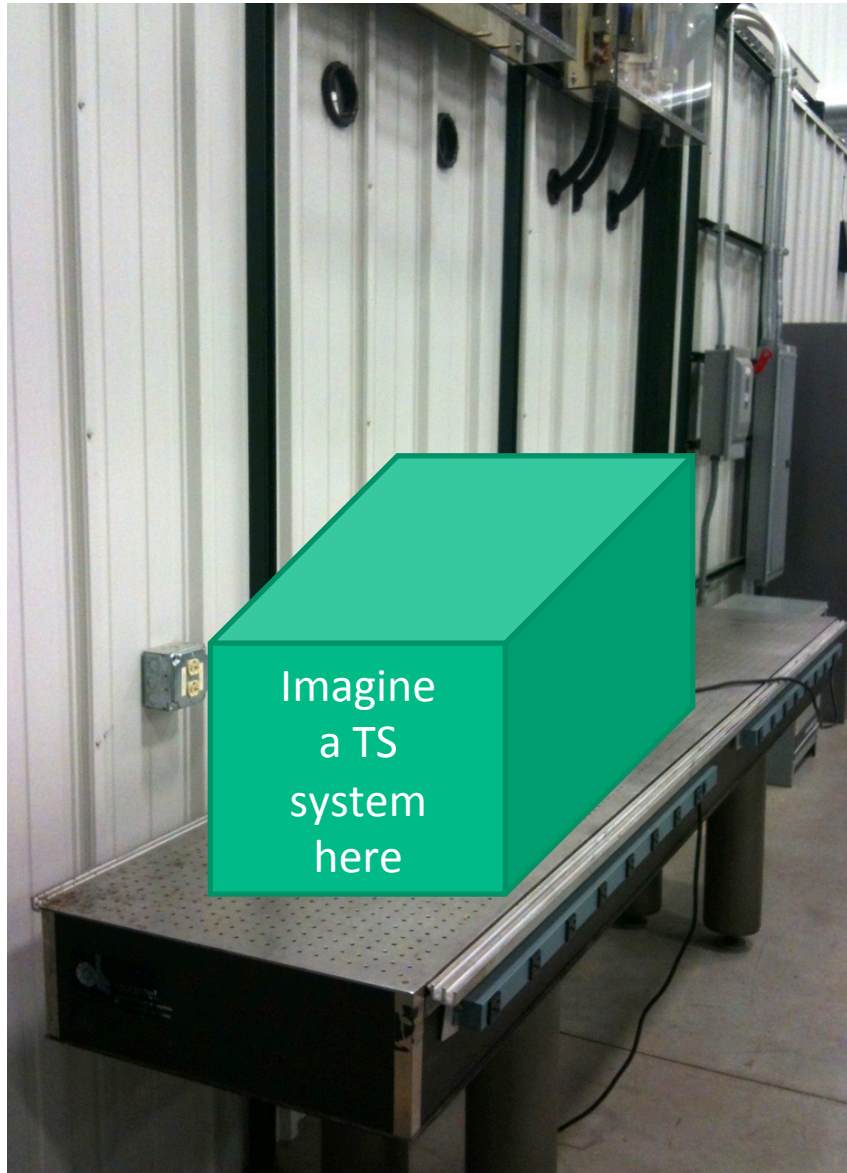

- **Optical table installed adjacent to PhIX hall.**
- **Spectrometer, iCCD camera, and coupling fiberoptics purchased on ORNL FY12 discretionary \$\$.**
 - **Delivered and tested.**
- **Fiberbundle, LD grating, slits, BP filter will return from JET.**
- **Without a Nd:YAG laser, the system will be used for OES with “in house” hardware.**

Optical Emission Spectroscopy

Low Dispersion Configuration

- 5290 Å “C VI” grating
 - Overlapping Nd:YAG coverage
 - W I (5220)
- 6328 Å “HeNe” grating
- 4686 Å “He/Be” grating
 - He I (4713), He II (4686), H β (4861)

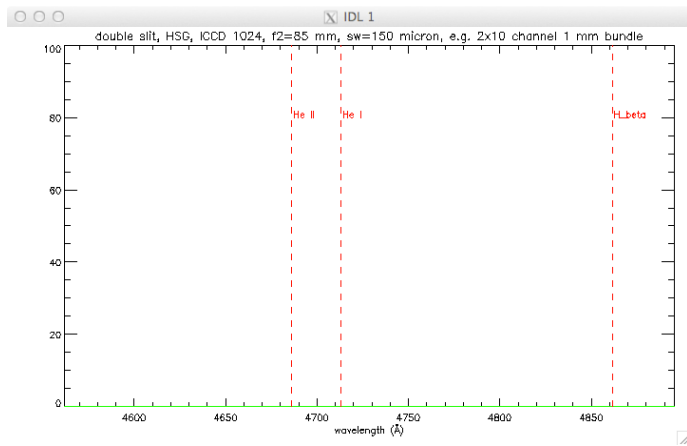

High Dispersion Configuration

- Would necessitate return of 1x17 fiberbundle from LTX, or as a single fiber slit/mount
- 4686 Å “He/Be” grating
 - He I (4713), He II (4686)
- 6560 Å “H α ” grating
 - H/He/D discrimination

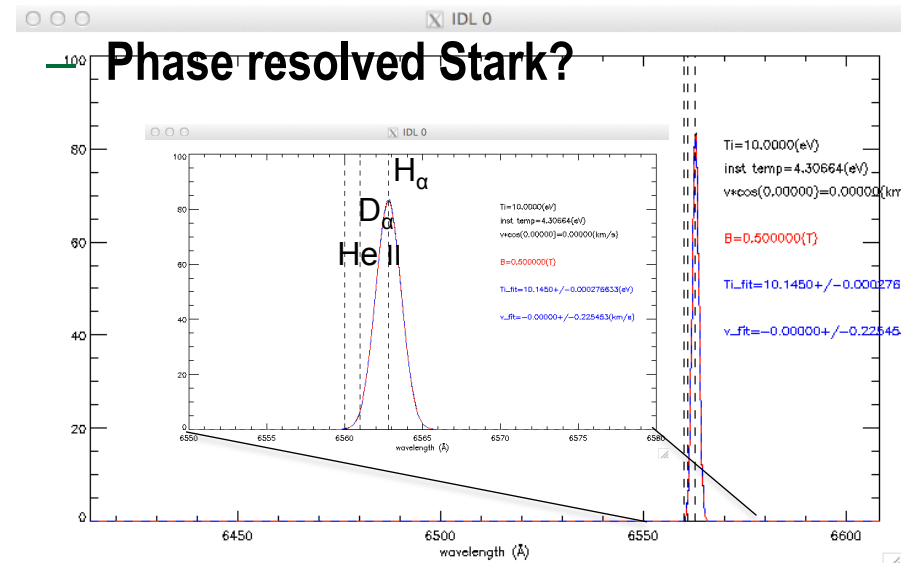

Example Multi-chord Viewing Optics

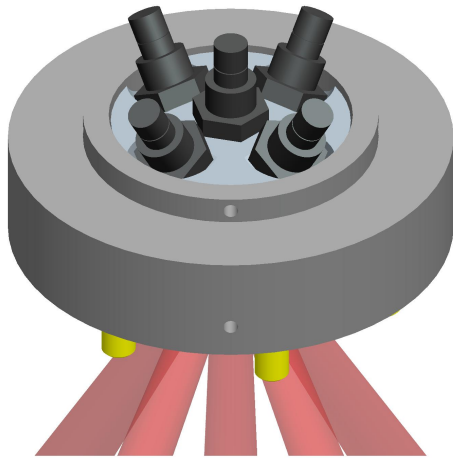

- Collimating (fused silica) lens attaches to fiber (SMA mount).
 - $f=10$ mm, $d=5$ mm: $f/2$ acromat
 - Ocean Optics 74-ACR
- Pucks positioned at multiple locations with mounting collars.
- Designed to fit standard size vacuum windows: 2-3/4", 4-5/8", 6", . . .
- Note: windows need to have cap head bolts, NOT hex-head.

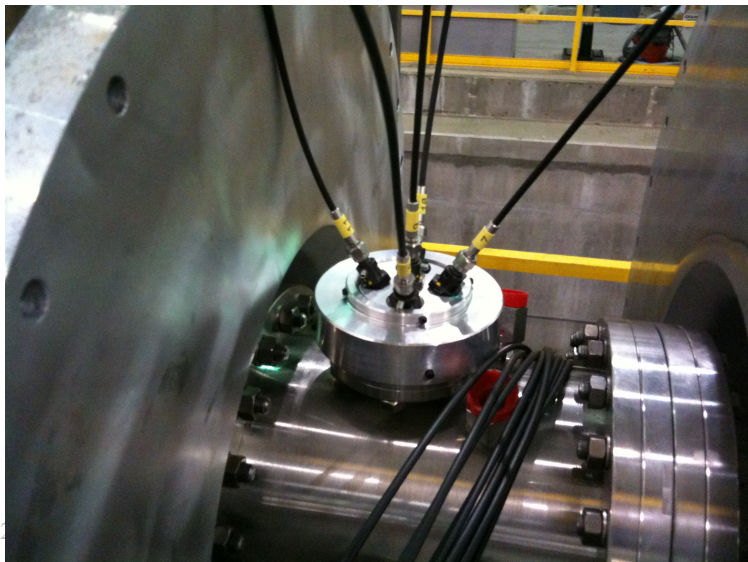

Multi-chord viewing geometry

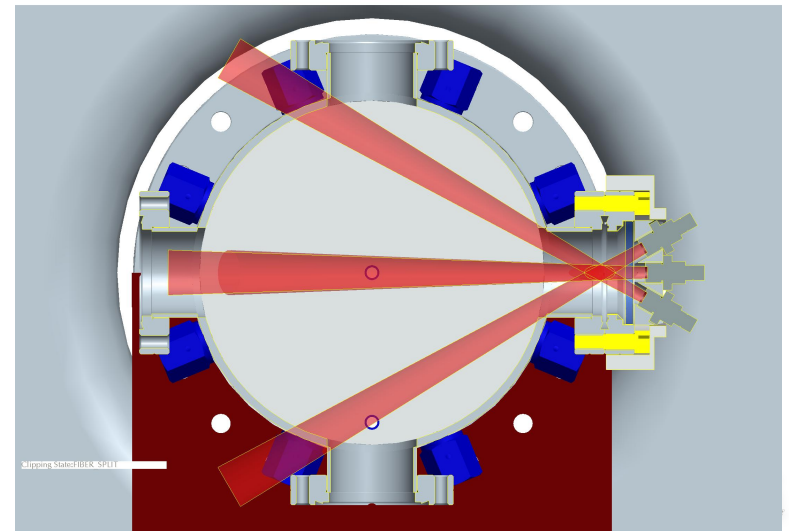
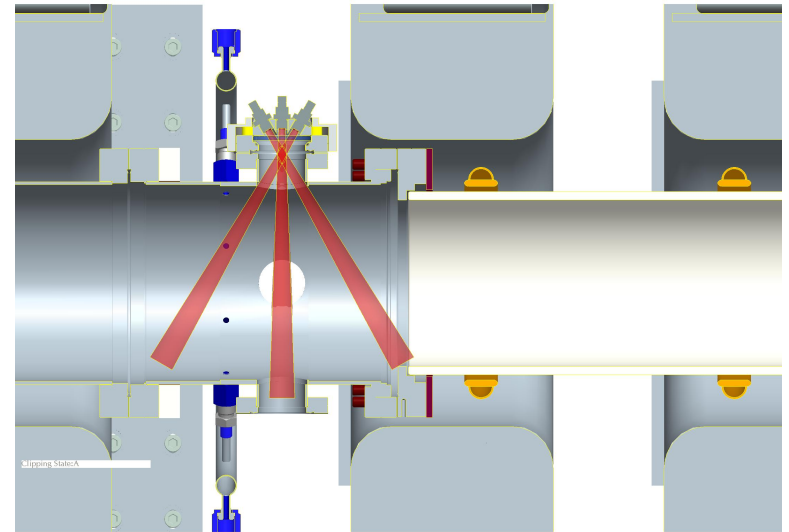
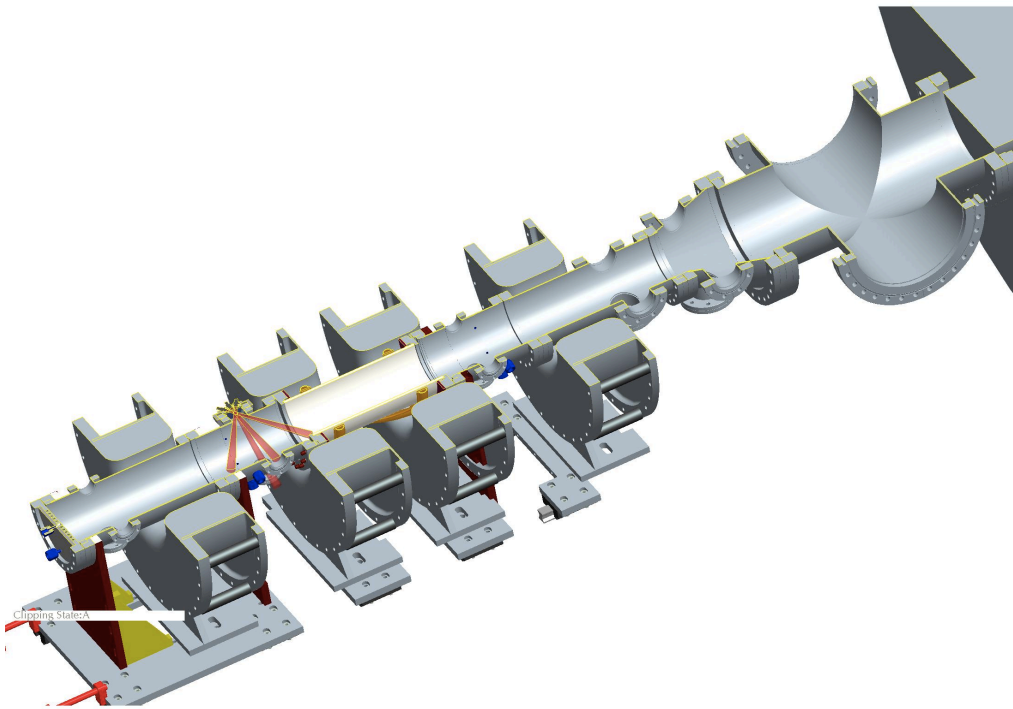







- **Sightlines allow for measurement of radial, axial, and azimuthal flow components.**
- **Multiple positions along device axis.**
- **Used previously on helicon LDRD.**

Summary

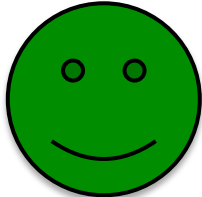
- **ORNL is assembling a linear test stand, called PhIX, to investigate the physics of rf sourced plasma-material interactions.**
- **The high power flux of PhIX is incompatible with probe based measurements, requiring the implementation of non-perturbative, laser-based diagnostics.**
- **An ORNL LDRD proposal was submitted to develop a novel, low-cost Thomson Scattering diagnostic system for PhIX. However, this LDRD was not funded.**
- **Fortunately, FY12 “discretionary funds” allowed the purchase of some off-the-shelf, strategic items: iCCD camera, spectrometer, coupling fibers.**
- **Other pieces of equipment are available at ORNL, allowing “most” of a TS system to be assembled. Missing key component is a Nd:YAG laser (and staffing).**
- **It is hoped that the Nd:YAG laser will be purchased from FY13 “discretionary funds”, if no other funding can be located.**
- **In the meantime, the existing hardware will be utilized to make optical emission spectroscopy measurements of PhIX plasmas.**

Cost breakdown

• Nd:YAG laser, 850 mJ:	\$45-60k	✘	
• Beam steering/dump:	\$10k	✘	
• Collection optics:	\$5k	✓	
• Fiber bundle:	\$10k	✓	
• Spectrometer, KOSI Holospec:	\$7k	✓	
• Grating, slits, BP filter:	\$10k	✓	
• Camera, PI-MAX3 1024i:	\$65k	✓	
• Hardware(table, clean air, misc)	\$15k	✓	
• Total of material costs:	<hr/> \$167-182k		
• Staffing (postdoc?):	+\$130k/yr	✘	

Workplan

- **FY 13: “optical emission spectroscopy” w/o Nd:YAG**
 - Spectrometer & CCD installed, aligned, calibrated
 - OES at low dispersion w/ 529 grating
 - Bremsstrahlung measurements (SNR) guide selection of target plane optical components and configuration
 - He II dynamics, W I dynamics, etc.
 - OES at high dispersion w/ 656 grating?
- **FY 14: “proof of principle” w/ Nd:YAG (if available)**
 - TS laser installed, and delivering beam into PhIX (or PHISX)
 - Single large collecting lens(es) on convenient port(s)
 - Implementation of target plane profile system
 - Systematic experiments and TS measurements

Reprints

- **Copies of this poster are available online:**
 - <http://sprott.physics.wisc.edu/biewer/APS2012poster.pdf>
- **Or, write your name and email address below:**